

Article number: 51030350000010

Description: Vibration damper GS-M2
70x45x2000-10, NR shore 57

Measures

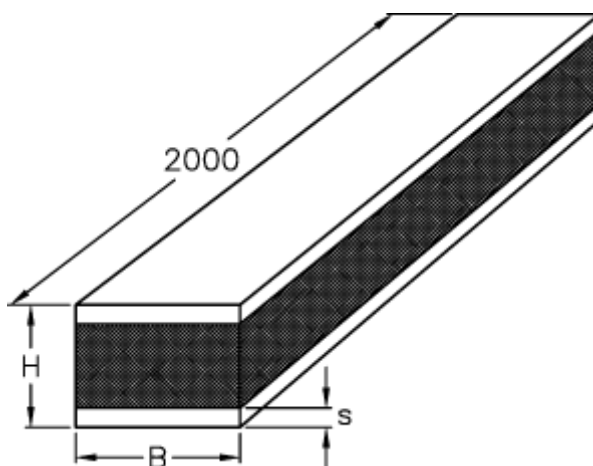

B = 70
H = 45
S = 10